

## E-4 Wireline Pressure Setting Assembly

Product Family H43702

Last Four Revisions					
Rev.	RDR	Amendment Detail	Reviewer	Approver	Effective Date
G	—/RM	No changes required, republished to new Baker Hughes Company rebrand	—	—	29 Jul 2019
G	<a href="#">3115</a> /RM	Removed C firing head information (OBSOLETE); added stroke length information to Table 1	Weinig, Gus	Jagunna, Babajide	29 Jul 2019
F	<a href="#">2406</a> /RM	Updated the maximum hydrostatic pressure for the size 20 heavy duty from 25,000 to 19,000 in the specification guide	Oberg, Levi	Jagunna, Babajide	08 Mar 2018
E	RDR-1452, 1616, 1714, 1434, 1844	Multiple RDRs applied	E. Dobies	W. LaBove	19 Apr 2016

BHOS CMS

Copyright 2012–2014, 2016, 2018–2019 Baker Hughes Company – All rights reserved. Baker Hughes Company and its affiliates (“Baker”) provides this information on an “as is” basis for general information purposes and believes it to be accurate as of the date of publication. Baker does not make any representation as to the accuracy or completeness of the information and makes no warranties of any kind, specific, implied or oral, to the fullest extent permissible by law, including those of merchantability and fitness for a particular purpose or use. Baker hereby disclaims any and all liability for any direct, indirect, consequential or special damages, claims for lost profits, or third party claims arising from the use of the information, whether a claim is asserted in contract, tort, or otherwise. The Baker Hughes logo and “Baker Hughes” are trademarks of Baker Hughes Company.

## Table of Contents

1	Introduction .....	3
2	Description .....	3
3	Features and Benefits .....	4
4	Engineering Tables and Information .....	4
	Table 1: Specification Guide .....	4
	Ordering Guide .....	4
	Accessory Equipment .....	5
	Required Accessory Equipment .....	5
	Table 2: E-4 Wireline Pressure Setting Assembly Accessory Equipment, Size 05 .....	5
	Table 3: E-4 Wireline Pressure Setting Assembly Accessory Equipment, Size 10 .....	6
	Table 4: E-4 Wireline Pressure Setting Assembly Accessory Equipment, Size 20 .....	6
	Product Selection Chart .....	6
5	HSE&S .....	7
6	Preservation of Product .....	7
	Storage Recommendations .....	7
7	Assembly and Dimensional Information .....	8
	E-4 Wireline Pressure Setting Assembly (Material H4370205E4RT) .....	8
	Figure 1: Assembly and Dimensional Data Drawing 390-979-00P02, Size 05 .....	8
	E-4 Wireline Pressure Setting Assembly .....	9
	Figure 2: Assembly Drawing 390-427-0P03, Size 10 .....	9
	E-4 Wireline Pressure Setting Assembly (Material H4370220E4RT) .....	10
	Figure 3: Assembly and Dimensional Drawing 390-426-00-3, Size 20 .....	10

## 1 Introduction

The E-4™ wireline pressure setting assembly (W.L.P.S.A.) is a device in which the products of combustion are utilized for the gradual development of force through pressure. This motive force operates the various working parts of the W.L.P.S.A. in a proper sequence to ensure the successful setting of Baker Hughes Company bridge plugs, retainer production packers, cement retainers, and other products.

## 2 Description

The pressure required is built up through the burning of a slow-set power charge (Product Family H43766), or a standard power charge, (Product Family H43764), which was originally known as a high-temperature power charge. For specifics on all power charges and igniters refer to Slow-Set Power Charge, Standard Power Charge, Secondary Igniter, BP-3S and BP-5S Igniter (Product Families H43766, H43764, H43743, and H43744), and Unit 4190 under Workover Systems. The setting pressure is confined to the proper area of the setting tool through the use of O-ring seals. It is of extreme importance that all O-rings be maintained in perfect condition and replaced after each use. The E-4 W.L.P.S.A. incorporates a piercing disk bleeder system to provide a safe, easy method of bleeding off trapped pressure before disassembling the W.L.P.S.A. after it has been run. The manual bleeder valve for size 05, 10, and 20 is obsolete. It has been replaced by the piercing disk bleeder system.

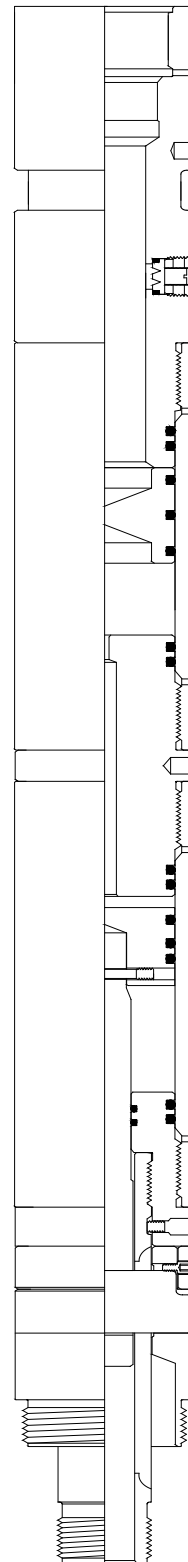

Drawing 390-426-00-3

### 3 Features and Benefits

- Used to set Baker Hughes bridge plugs, cement retainers, and production packers on electric wireline
  - Risk aversion on equipment compatibility.
- Used in conjunction with a casing collar locator for correlation of exact setting depth
  - Accurate equipment placing.
- Uses the advantage of the fast running capability of wireline
  - Wellsite cost savings.
- Proven design has been the industry standard for many years
  - Reliable well sight performance.
- Sizes available for setting inside 2-3/8-in. tubing up to the largest casing
  - Available for all well program sizes.

### 4 Engineering Tables and Information

Table 1: Specification Guide

Description	Size				
	05	10		20	
		Standard	Heavy Duty	Standard	Heavy Duty
Maximum hydrostatic pressure (psi) at setting depth	27,000	15,000	30,000	15,000	19,000
Maximum setting force (lb)*	10,000	35,000		55,000	
Maximum operating temperature (°F)	400				
Maximum outside diameter (in.)	1.718	2.750	3.250	3.800	4.125
Length (less firing head)	74.16	63.80		74.84	
Stroke length (in.)	6.000	7.500		10.984	

\*The force output of the E-4 wireline pressure setting assembly is a function of well conditions, and the characteristics of the device that is being set. The E-4 W.L.P.S.A. will generate sufficient force to set standard Baker Hughes bridge plugs, packers and other products under specified conditions. Other manufacturer's devices should be tested before attempting to set with the E-4 W.L.P.S.A.

It is imperative that the specification guides for the various tools set with the E-4 W.L.P.S.A. be followed strictly in regard to the size E-4 W.L.P.S.A. used to set the various sizes of the tools.

#### Ordering Guide

Not applicable.

## Accessory Equipment

### Required Accessory Equipment

#### Igniters

The E-4 W.L.P.S.A. is designed to operate with either a BP-3S (Material H437442200) or a BP-5S (Material H437444200), primary igniter and a secondary igniter (Material H437431000). Refer to the Baker Hughes Slow-Set Power Charge, Standard Power Charge, Secondary Igniter, BP-3S and BP-5S Igniter (Product Families H43766, H43764, H43743, and H43744) Unit 4190 under Workover Systems.

#### Power Charge

The E-4 W.L.P.S.A. is designed to operate with a standard power charge (Material H437641500) for the size 05 and either a standard power charge (Material H437642113 for size 10; Material H437643223 for size 20) or slow set power charge (Material H437660010 for size 10; Material H437660020 for size 20). Refer to Baker Hughes Slow-Set Power Charge, Standard Power Charge, Secondary Igniter, BP-3S and BP-5S Igniter (Product Families H43766, H43764, H43743, and H43744), Unit 4190 under Workover Systems for further information.

#### Firing Head

The E-4 W.L.P.S.A. utilizes a firing head which connects the wireline pressure setting assembly to the cable head or collar locator on the electric line and provides a means of electrically igniting the power charge, through the igniter, and a secondary igniter.

The firing heads are manufactured with the top end blank, for threading, so that it can be machined to fit the operator's cable head or collar locator.

**Table 2: E-4 Wireline Pressure Setting Assembly Accessory Equipment, Size 05**

Refer to Drawing 390-979-00P02.

Item	Description	Qty. Req'd	Size and Material
			Size 05
27	Spanner Wrench	1	H016418100
28	Bleeder Wrench Assembly	1	H039098700
28A	Bleeder Housing	1	H036115800
28B	Hex Socket Set Screw	2	HWWG51H0S0 (1/2-13x3/4 lg)
28C	Piercing Screw	1	H036224000

**Table 3: E-4 Wireline Pressure Setting Assembly Accessory Equipment, Size 10**

Refer to Drawing 390-427-00P03.

Item	Description	Qty. Req'd	Size and Material
			Size 10
24	Spanner Wrench	1	H012421900
25	Bleeder Wrench	1	H039047500
26	Anchor Bolt	1	H038101200
27	Disk Retainer Socket	1	H038100500

**Table 4: E-4 Wireline Pressure Setting Assembly Accessory Equipment, Size 20**

Refer to Drawing 390-426-00-3.

Item	Description	Qty. Req'd	Size and Material
			Size 20
21	Spanner Wrench	1	H012059700
22	Bleeder Wrench	1	H039047500
26	Anchor Bolt	1	H038101200
27	Disk Retainer Socket	1	H038100500









**Product Selection Chart**

Not applicable.

## 5 HSE&S



Read, understand and follow all Baker Hughes Company instructions and specifications in this unit while assembling, disassembling, maintaining or repairing this equipment. Failure to do so may result in property damage, serious injury or fatality.

 <b>WARNING</b>	
      	<p>After the firing head and wireline pressure setting assembly (W.L.P.S.A) have been run and fired; high pressure gas will be trapped inside the tools. This high pressure gas must be bled off before beginning disassembly. Failure to comply with the following bleed-off guidelines may result in serious bodily injury</p> <ul style="list-style-type: none"><li>• Do not perform the bleed-off procedures while the W.L.P.S.A. is suspended in the air by the wireline.</li><li>• Wear safety glasses, gloves, long sleeves, and hearing protection while bleeding pressure off of the W.L.P.S.A.</li><li>• Establish a restricted area for bleeding the setting tool, and post Danger placards around the area.</li><li>• All non-essential personnel must remain clear of the restricted area until the W.L.P.S.A. has been completely bled off.</li><li>• Ensure that the vent holes are pointed away from all personnel and are pointing in the downwind direction.</li><li>• Always bleed the W.L.P.S.A. in a well-ventilated area.</li></ul>

## 6 Preservation of Product

For preservation of product requirements refer to the global procedure for *Preservation of Product (QA-GLB-En-100042)* located on Baker Hughes Operating System (BHOS).

### Storage Recommendations

Store setting tools in a cool, dry place.

### 7 Assembly and Dimensional Information

#### E-4 Wireline Pressure Setting Assembly (Material H4370205E4RT)

Figure 1: Assembly and Dimensional Data Drawing 390-979-00P02, Size 05

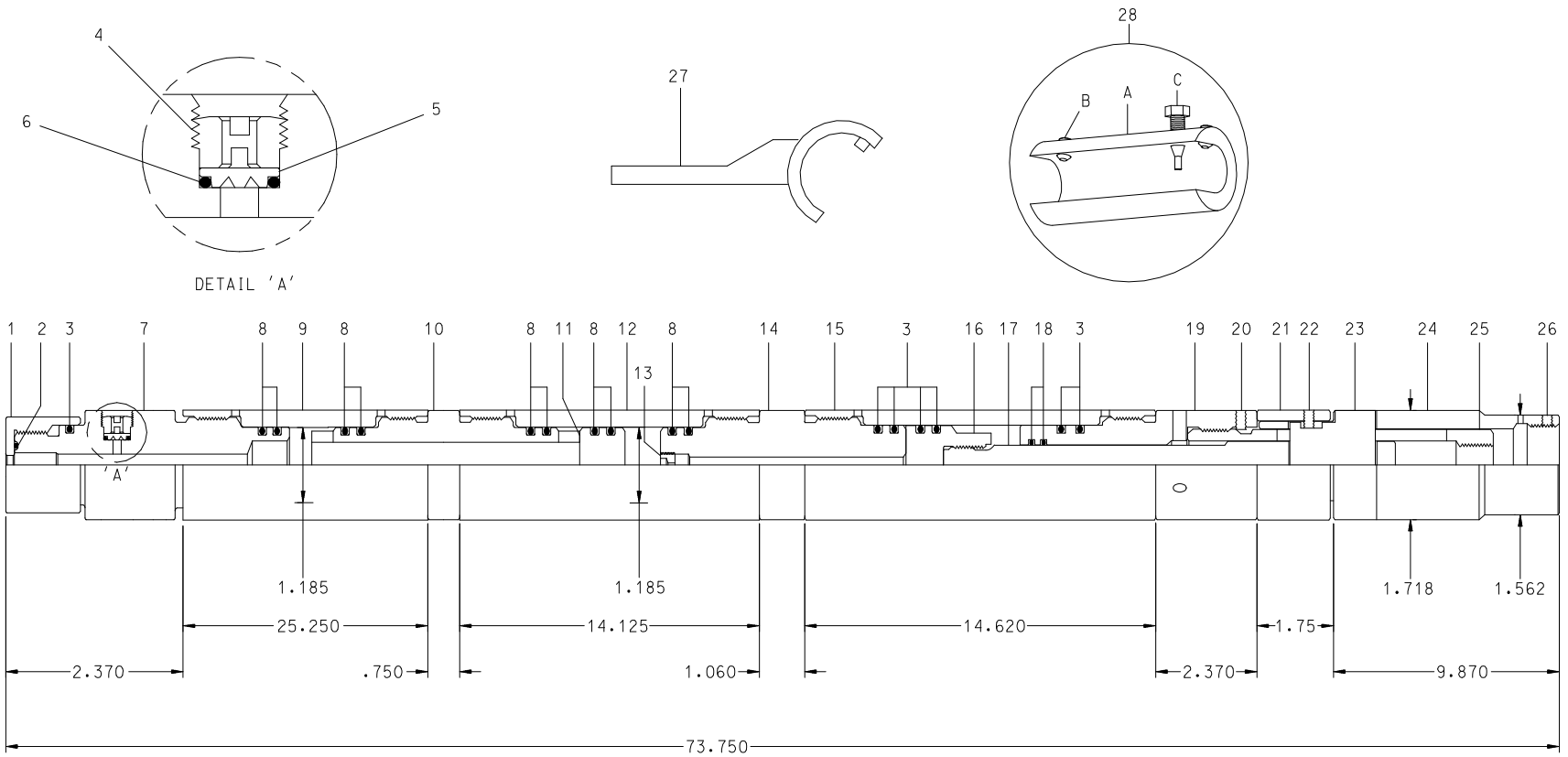



E-4 Wireline Pressure Setting Assembly  
Figure 2: Assembly Drawing 390-427-0P03, Size 10

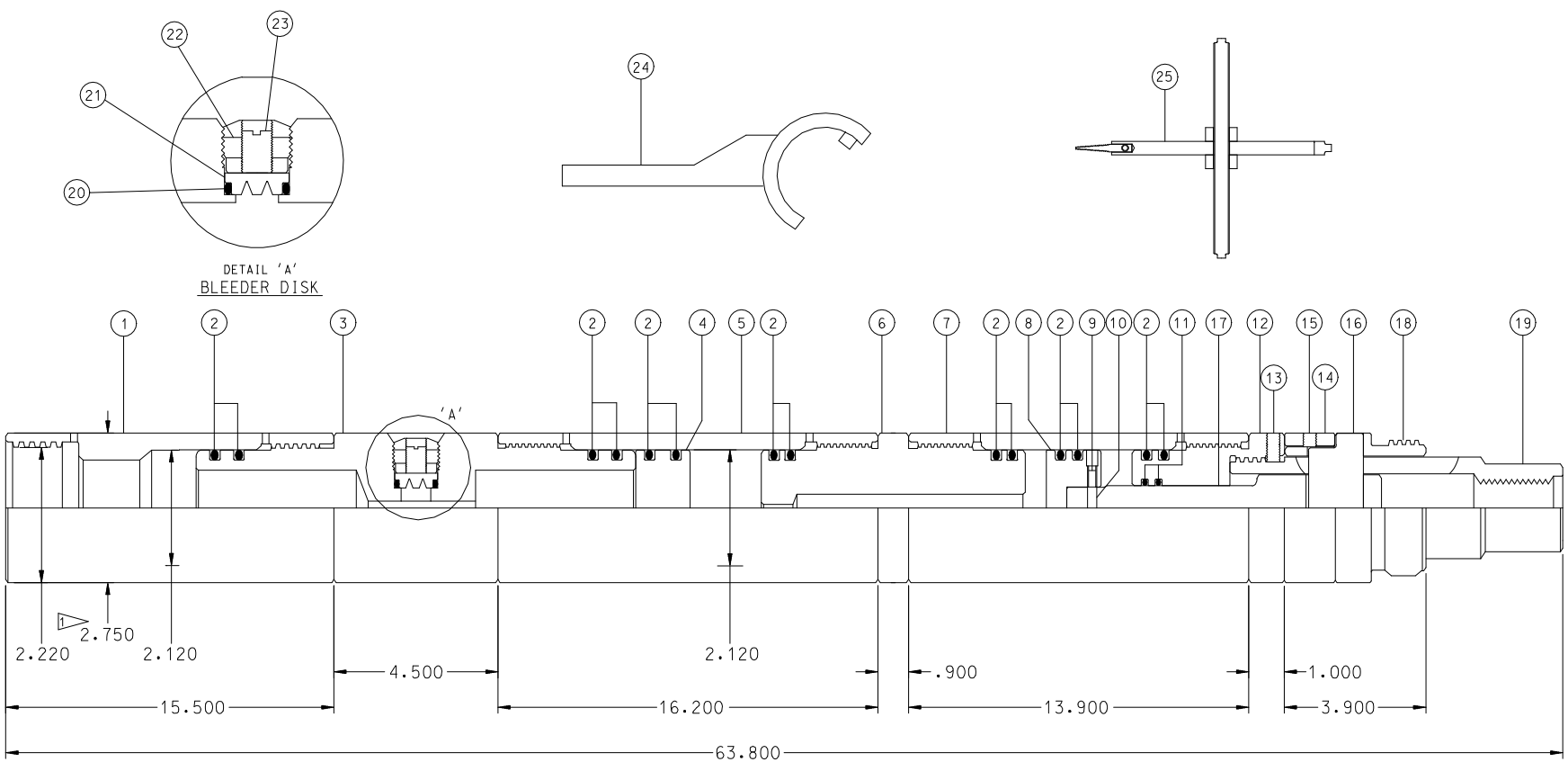

### E-4 Wireline Pressure Setting Assembly (Material H4370220E4RT)

Figure 3: Assembly and Dimensional Drawing 390-426-00-3, Size 20

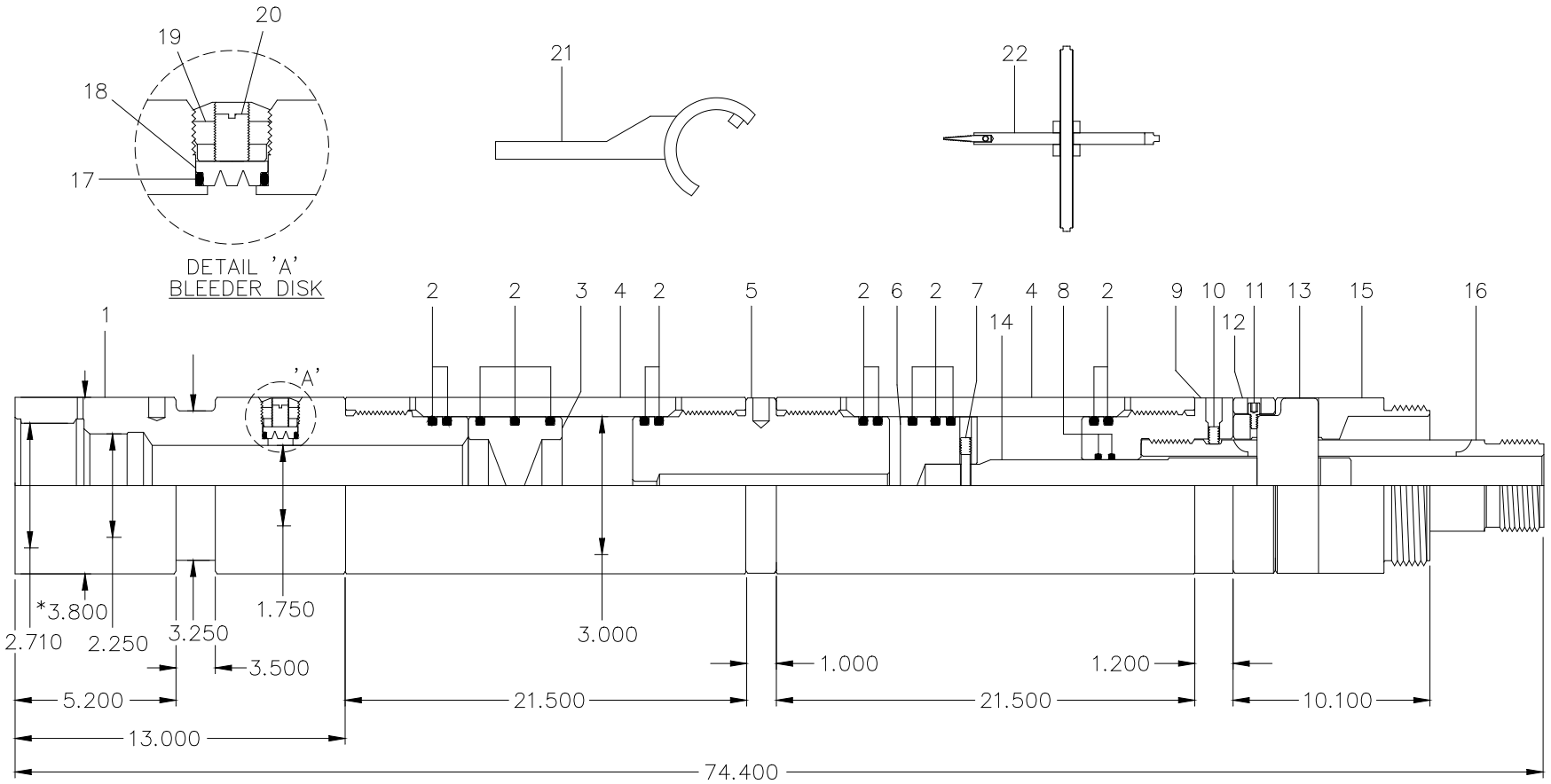

\* HEAVY DUTY CYLINDER O.D.- 4.125